

**Proposal for a Tutorial on
Koopman Operator and Lifting Linearization:
Emerging Theory and Applications of Exact Global Linearization of Nonlinear
Robotic Systems**

2022 IEEE ICRA

1. Type and Duration:

Tutorial, Half Day

2. Title:

Koopman Operator and Lifting Linearization: Emerging Theory and Applications of Exact Global Linearization of Nonlinear Robotic Systems

3. Organizer:

Harry Asada – Primary contact

Department of Mechanical Engineering
Massachusetts Institute of Technology

77 Massachusetts Ave., MIT Room 3-346
Cambridge MA 02139

asada@mit.edu
<http://darbelofflab.mit.edu/>

4. URL:

<http://darbelofflab.mit.edu/2022-icra-tutorial/>

5. Abstract:

A game-changing theory is emerging and is making significant impacts on broad fields of robotics. Complex nonlinear dynamics of robotic systems can be represented as linear systems in a higher dimensional space. Unlike traditional linearization which is accurate in local regions, lifting linearization is valid globally. Underpinned by the Koopman Operator theory, nonlinear dynamics can be linearized precisely when the system is recast to a lifted space consisting of supernumerary state variables, called observables.

Nonlinearity is everywhere in robotics, ranging from dynamic control of multi-link arms, legged robots, aerial and underwater vehicles to manipulation and navigation of diverse robots. These nonlinearities can be dealt with in a unified manner based on lifting linearization. A wealth of powerful linear system tools can be applied once the governing equations are linearly represented.

In this tutorial, this emerging theory will be introduced to the broad audience of robotics. The theoretical foundation will be concisely and clearly explained; various techniques and algorithms will be taught in a way that is easy to follow without advanced mathematics background; and various applications of the theory, including Model Predictive Control, active learning, and hybrid control of robots and vehicles, will be presented.

6. Content:

Among many ICRA/IROS workshops addressing recent research challenges in narrowly defined, specific areas, this TUTORIAL will play a unique role in addressing fundamentals that can be applied to a broad spectrum of robotics. Participants will learn something exciting and useful that they may have never thought was possible. There are huge opportunities that benefit the robotics society from this theory. The organizer believes that within 5 years, people will recall this tutorial as an inspirational event of the 2022 ICRA.

Nonlinearity is essential in robotics. The dynamics of multi-rigid body systems have profound nonlinearities, like Coriolis and centrifugal terms; even a single joint servo has a complex frictional nonlinearity; drones are governed by nonlinear aerodynamics; underwater vehicles exhibit complex nonlinear dynamics due to nonlinear drag forces and others; legged robots go through diverse phases of leg-ground contacts, which are nonlinear and hybrid; contact-noncontact behaviors in manipulation are profound nonlinearities; multi-cable suspension robots experience pronounced nonlinearities when the cables go slack or become taut, etc.

Nonlinearity is complex and everywhere in robotics; if robotics systems were linear, they would be trivially simple. In each branch of robotics, nonlinearity has been treated as a domain-specific, problem-specific manner using diverse methods and tools. Traditional methods for treating nonlinearity are often limited in validity or specific to the problem. The standard point-wise linearization based on Taylor expansion, for example, is valid only in the vicinity of the original nonlinear system. The Lyapunov method is a general theory, but a specific Lyapunov function must be crafted for each problem. While these traditional methods are useful for specific problems and domains, it would be groundbreaking if the robotics community would assimilate a new methodology and exploit it for solving complex nonlinear problems in a manner that is general and unified, rather than specific to particular problems and limited to a local region.

This tutorial teaches the Koopman Operator theory for the robotics researchers and practitioners. In his seminal work published in the Proceedings of National Academy of Science (PNAS) in 1931, Koopman showed that nonlinear dynamical systems can be represented as linear systems in a lifted space. It is not an approximation, but an exact representation in a global sense. In lifting the dimension of the space, not only independent state variables but also additional, supernumerary variables are involved. The original theory, however, applies to autonomous systems having no exogenous input. Furthermore, the dimension of the lifted space is infinite to obtain the exact representation. Due to these limitations, the Koopman Operator theory had not gained much attention in the engineering communities for many decades. Recently, however, a series of breakthroughs have been made. The method is now applicable to non-autonomous systems with exogenous inputs, and effective methods for reducing the otherwise infinite dimensional space to a manageable space have been developed. Furthermore, the method meets the increasing need for the data-driven approach using a vast amount of data. Those methods underpinned by the Koopman Operator theory have been applied to broad engineering and science fields, including robotics. This tutorial will expose the broad audience of the robotics community to the Koopman Operator theory, its methods extended to practical problems, and successful applications to various robotics problems.

The original tutorial content is based on a graduate subject at the Massachusetts Institute of Technology, 2.160 Identification, Estimation, and Learning. Four lectures (6 hours) on this topic involved in the graduate subject will be modified, streamlined, and re-tuned to the robotics audience for this half-day tutorial. The planned tutorial consists of A) Lectures, B) Interactive Case Studies, and C) Short Talks on Applications by robotics researchers.

Tentative Program (assuming 4 hours in length)

Welcome and Introduction (0:00 – 0:10)

Part A – Lectures, Harry Asada (0:10 – 2:10)

0:10 – 0:40 Lecture A-1: Introduction to Lifting Linearization and Koopman Operator

0:40 – 1:10 Lecture A-2: Dynamic Mode Decomposition

1:10 – 1:40 Lecture A-3: Finding Effective Observables

1:40 – 2:10 Lecture A-4: Causality

2:10 – 2:30 Break

Part B - Robotics Impacts: An Interactive Session, Harry Asada (2:30 – 3:15)

2:30 – 2:45 Robotics Impact B-1: Model Predictive Control

2:45 – 3:00 Robotics Impact B-2: Active Learning

3:00 – 3:15 Robotics Impact B-3: Hybrid Control

Part C – Case Studies (3:15 – 4:00)

3:15 – 3:30 Case Study C-1: Soft robotics modeling and control- Speaker to be announced

3:30 – 3:45 Case Study C-2: Autonomous excavator robots - Filippos Sotiropoulos

3:45 – 4:00 Case Study C-3: Multi-cable suspension robots - Jerry Ng

Part A Lectures:

Lecture A-1: Introduction to Lifting Linearization and Koopman Operator

- As an introduction to lifting linearization, the tutorial will start with a simple example of a 2nd order nonlinear dynamical system that can be linearized exactly by increasing the dimension of the space from 2 to 3. See Figure 1 below. The complete dynamic behaviors can be represented as a 3rd order linear differential equation. The projection of the 3-dimensional trajectories on to the 2-dimensional independent state space, the dynamic behaviors become nonlinear. The complex nonlinear dynamics can be analyzed and predicted as a linear problem in the lifted space.
- Controllability and observability are addressed, and optimal control will be applied to a nonlinear system, which is represented as a linear system in a lifted space. Model Predictive Control will be discussed briefly and the impact of exact linearization upon computational load reduction and convex optimization will be discussed.
- The example discussed is a special case where a finite dimensional lifted space can represent the nonlinear system exactly. In general, the order of the lifted system goes to infinity. This was precisely addressed by Koopman in Hilbert space.
- The theory of Hilbert Space will be briefly summarized, and the Koopman Operator theory is introduced.
- The two major issues will be identified. One is that the theory applies only to autonomous systems with no exogenous input, and the other is that the dimension of the lifted space is infinite. These issues will be discussed in the following lectures.

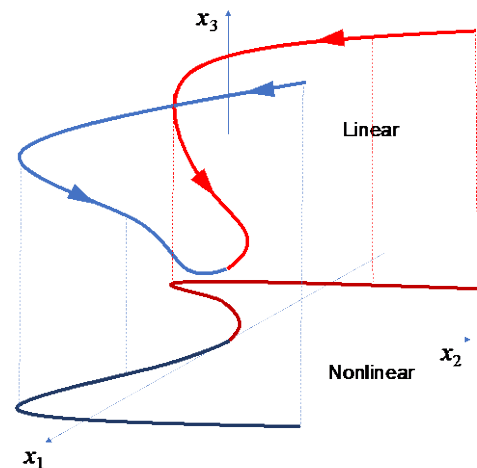

Lecture A-2: Dynamic Mode Decomposition

- Dynamic Mode Decomposition is a method for extracting underlying linear dynamics from data of a complex nonlinear system. The extracted model provides a global modal representation of the nonlinear system, which is underpinned by the Koopman Operator theory. DMD connects the Koopman Operator theory to the data-driven approach.
- Two algorithms will be discussed. One is the Arnoldi method using a companion matrix derived from data matrices. The other is the method based on Singular Value Decomposition (SVD).
- Two extensions of the basic DMD will be discussed. One is Extended DMD, where in addition to the original data, synthetic data computed from independent state variables are used for augmenting the data.
- The other is to extend the original autonomous system with no input to non-autonomous systems with control inputs.
- Numerical examples will be discussed to demonstrate the DMD algorithms.

Lecture A-3: Finding Effective Observables

- One of the challenges in applying the Koopman Operator theory is to find a set of nonlinear functions, called observables, that can approximate the original nonlinear system effectively. The accuracy of a finite dimensional linear system is highly dependent on the choice of observable functions. Several methods will be introduced and numerically compared.
- A simple method is to use classes of standard basis functions, such as polynomials and radial basis functions, which are nonlinear functions of independent state variables.
- A number of observables are often required for accurately represent the original nonlinear dynamics. A method for reducing the order of the lifted space will be discussed and verified through numerical examples.
- Neural networks can be used for obtaining effective observables from data through learning. Namely, a combination of neural units can serve as an observable, and the weights can be tuned in such way that a collection of neural observables can approximate the original nonlinear system accurately.
- An alternative to these purely mathematical and black-box, data-driven methods is to exploit physical knowledge of nonlinear dynamical systems. If a nonlinear dynamical system consists of a network of nonlinear elements that are physically meaningful, useful observables can be identified based on the knowledge of the elements connectivity. The method called Dual-Faceted Linearization (DFL) uses outputs of nonlinear elements as observables, which pertain to the key nonlinear properties of the nonlinear dynamics. The method allows for obtaining a lower order lifted space for approximating the nonlinear dynamics.

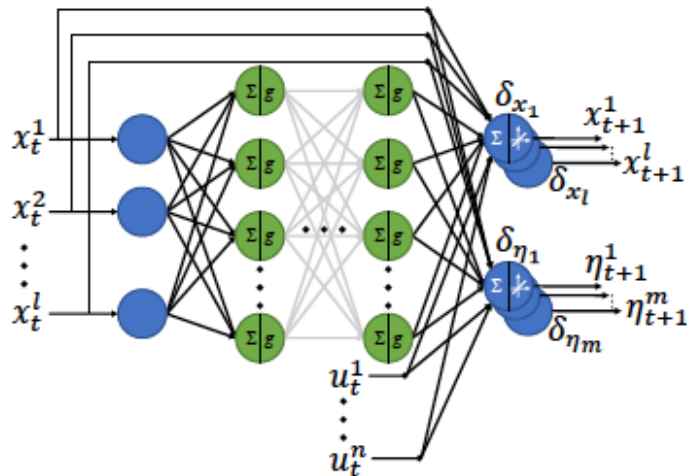

Lecture A-4: Causality

- There is a caveat in applying lifting linearization to nonlinear dynamical systems with control inputs and exogenous inputs. Most robotics applications are dynamical systems driven by control inputs and exogenous inputs. If data are collected from a system perturbed by control inputs and the system is lifted with respect to those observables in the data, it is likely that the obtained linear lifted model is not causal. If at least one of the observables is a nonlinear function of both state variables and inputs, the time derivative of such an observable inevitably includes the time derivative of the input. The state transition equation obtained for the lifted space turns out to be anti-causal because of the input time derivative; it requires future information.
- Methods for preventing anti-causal lifting linearization from occurring will be presented. Based on physical system modeling theory, we will investigate how control inputs directly affect observables, which results in the causality problem when differentiating the observables. A few methods to eliminate the direct paths from control inputs to observables will be discussed.
- To conclude the lecture part, numerical comparisons among different methods, including the original Koopman operator method, DMD, DMD with control, DFL, Neural net based methods, and causal lifting linearization, will be presented and pros and cons of each method will be discussed.

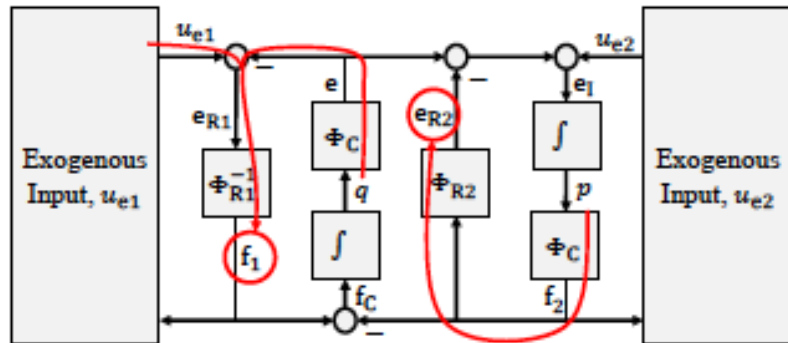

Part B - Robotics Impacts: An Interactive Session

Following the four segments of lectures on Koopman Operator and Lifting Linearization, we will discuss the impacts of the theory upon three specific areas of robot modeling and control. This session will be interactive. The instructor will provide a brief description of each modeling and control problem and ask questions to the participants.

Robotics Impact B-1: Model Predictive Control (MPC)

MPC is one of the most widely used control methods in robotics. However, real-time computation is a challenge when the system is nonlinear. Lifting Linearization can remove such a hurdle by reducing the nonlinear MPC to linear MPC.

Questions to be discussed: Is the linear model accurate enough for MPC computation? How can we determine the time horizon? The lifted dynamical system is not controllable in the augmented space, since the augmented variables are dependent variables of independent state variables. Can we still use MPC?

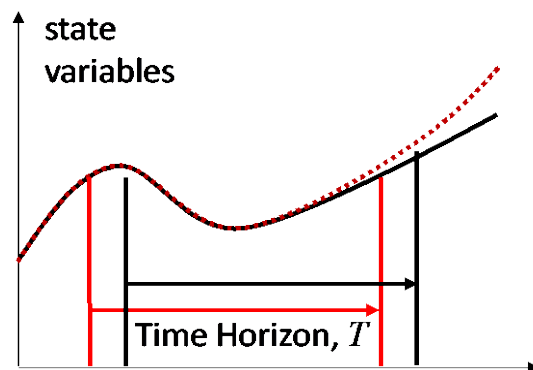

These are stimulating questions. The audience having some experience with MPC will actively participate in the discussion.

Robotics Impact B-2: Active Learning

Active learning is an active research area, where many robotics researchers are involved. The seminal work by Ian Abraham and Todd Murphey, which won the 2019 TRO Best Paper Award, applied the Koopman Operator theory to active learning, leading to a novel algorithm of active learning. We will review their work and related publications, and then discuss the impact of the Koopman operator.

Questions to be discussed: What are new possibilities and opportunities in exploiting the Koopman operator for active learning? What sort of remaining questions and gaps exist?

The audience interested in active learning will be engaged with this discussion.

Robotics Impact B-3: Hybrid Control

Hybrid dynamics is another class of nonlinear dynamical systems. A number of robotic systems are hybrid in nature. Legged robots, for example, exhibit hybrid dynamics, repeating a cycle of diverse leg-ground contact states, each governed by different dynamics. Traditional modeling and control methods represent such hybrid dynamical systems as a collection of diverse dynamics with complex switching conditions. The Koopman operator and lifting linearization have the potential to represent a hybrid system with a unified, linear system in a lifted space. This will be a completely different approach to dealing with the complex hybrid nature of dynamics. Powerful linear control methods can be brought to this field, pointing in a future direction of many robotics system research. Recent research results of the organizer's group will be discussed.

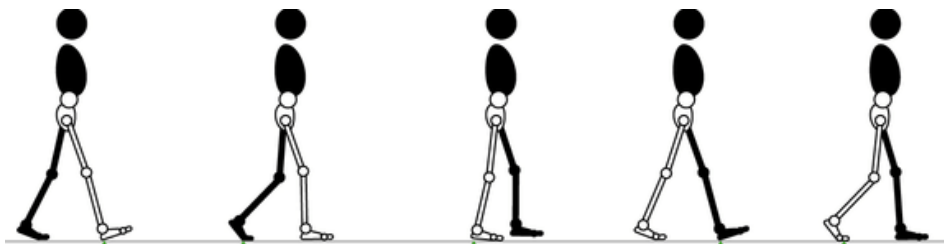

Part C – Case Studies

Three case studies on the application of Koopman Operator and Lifting Linearization will be presented by invited speakers.

Case Study C-1: Soft robotics modeling and control- Speaker to be announced

Soft robotics present challenging modeling problems due to the complexity of nonlinear properties of soft materials and pneumatic actuation. The Koopman operator has been successfully applied to soft robotics modeling and control by a few research groups, including the one at MIT. One of the authors of these works will be invited to this session.

Case Study C-2: Autonomous excavator robots - Filippos Sotiropoulos

Excavator robots interact with soil and rocks. The dynamic behavior of a bucket interacting with soil and rocks is highly complex and nonlinear. Recently, Lifting Linearization based on DFL has been applied to excavation process modeling and contouring control. One of the authors of the seminal work will present their work.

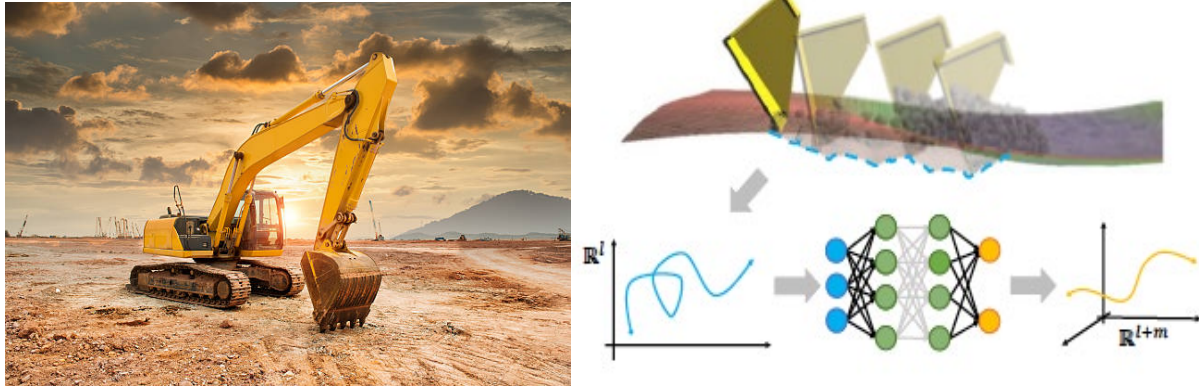

Case Study C-3: Multi-cable suspension robots - Jerry Ng

Cables can bear a unidirectional load. When compressed, cables go slack. This leads to a type of hybrid dynamics. Lifting linearization based on the Koopman operator can provide us with a unified, global representation of the nonlinear hybrid system. MPC control using a unified, linear model has achieved dexterous manipulation of an object suspended with multiple cables. The lead author of the recent paper will present the work.

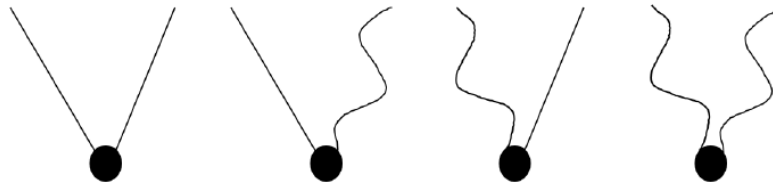

Statement: The tutorial organizer has read and will abide by the IEEE RAS Code of Conduct.

7. Plan to Solicit Participation

It will be a timely offer if this tutorial proposal be accepted. There is an increasing interest in the Koopman operator and lifting linearization within the robotics community as well as in system dynamics, control, and machine learning communities, which are overlapped with the robotics community. The organizer plans to disseminate the tutorial announcement to those communities through their community news letters, fliers at related conferences, and targeted emails.

As of 2020, over 40 papers have been published on Koopman and lifting linearization in robotics, system dynamics and control, machine learning and mathematics journals and proceedings. It is expected that more papers will be presented in 2021 and 2022. The organizer will make an email list of those authors and send personal emails (not a bulk email but targeted emails) to those authors and their research groups, expressing personal invitations to those.

Beyond the targeted audience group, we will disseminate the tutorial announcement through personal connections of the organizer's group to major robotics research institutions, including the Carnegie-Mellon Robotics Institute, MIT's robotics groups at CSAIL and MechE, U-Penn's GRASP Lab, and many others. We will also contact the Robotics Society of Japan and other foreign organizations and societies for disseminating the tutorial announcement. The last thing to do is announcement in Robotics-WorldWide. In our experience, targeted emails and personal contacts are more effective.

8. Plan to Encourage Interaction among Participants

Two plans are considered. One is to organize an interactive session, as described in the Content section. The instructor will prepare a few questions on each of the impactful research areas: Model Predictive Control, Active Learning, and Hybrid Systems. The Koopman operator and lifting linearization have been applied successfully to these areas, but many questions have been raised. We will solicit participation of each of these popular research areas and discuss those stimulating questions with the targeted audience group.

The other plan is to solicit speakers of case studies. At the time of submitting this tutorial proposal two case study presenters have been confirmed. We can add a few more to Part C Case studies session.

9. Dissemination

As mentioned previously, the tutorial materials are based on MIT's graduate subject. The lecture notes created for the course will be shared with the tutorial participants. After the tutorial, an extended version of the lecture notes will be produced, which will include the materials presented at the case studies session. This extended lecture notes will be a valuable reference for students, researchers, and industrial professionals. The lecture notes will be first disseminated to the participants of the tutorial and the 2022 ICRA attendees. Later the lecture notes will be made publicly accessible through MIT's Open Course Ware and d'Arbeloff Lab's website. These lecture notes are original materials written by the organizer and will not interfere with any existing copyright. However, before dissemination, the organizer will double check the copyright issue and perform quality control.

In an effort to promote broader participation, the organizer will a) include works done by minority and under-represented authors, b) make their involvement visible, and c) reach out to encourage them to participate in the tutorial. The organizer's group includes several minority and under-represented students who are active in robotics research and are role models. They will participate in the tutorial, if it be accepted.